

# scand LIGHT

## T-BAR Lightset COB USER MANUAL

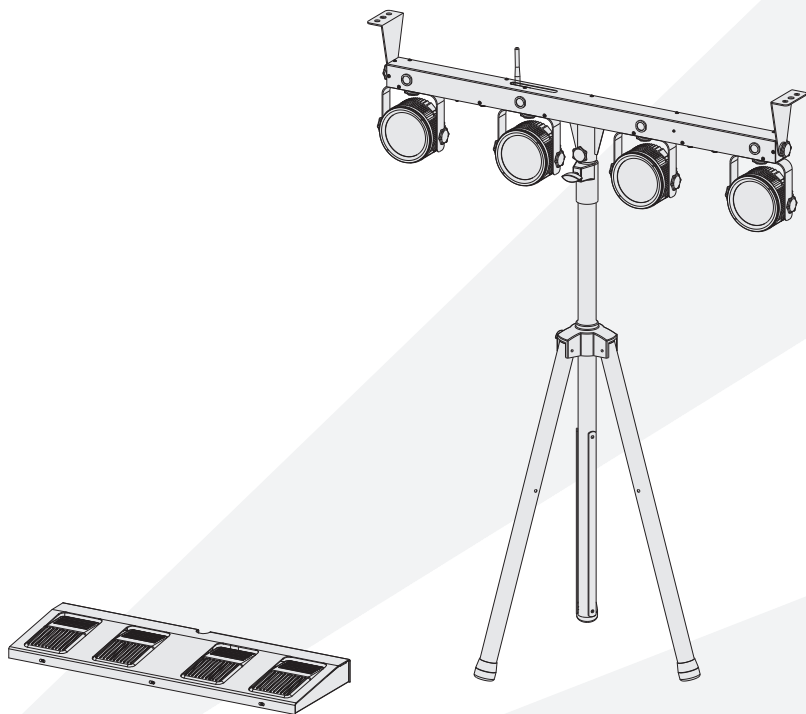

Version 1.0

Art nr: 943566



# Unpacking Instructions

---

## Read Manual before Operation

Dear user,

Thanks for choosing our LED device, believing this brand new product will bring you unlimited marvel and happiness. Before operating this device, please read this manual thoroughly, and retain it for future reference.

## Warning Data

Please note the warnings in bold which will ensure the safe and smooth operation. These warnings are important to a certain extent.



**Attention!** Indicates a skill or other useful information for special situations.



**Important!** Indicates important information to protect personnel from laser incident or injury.



**Caution!** Prevent damage or injury from incorrect operation.

### Warning!

If the external flexible cable or cord of this luminaire is damaged, it shall be replaced by a special cord or cord exclusively available from the manufacturer or his service agent.

Shields, lenses or ultraviolet screens shall be changed if they have become visibly damaged to such an extent that their effectiveness is impaired, for example by cracks or deep scratches.

The lamps shall be changed if it has become damaged or thermally deformed.

## Unpacking Instructions

As receiving a fixture, carefully unpacking the carton, checking contents to ensure that all parts are in good condition. Informing the shipper immediately and retaining packing material for inspection if any parts damaged from shipping or device damaged. Keeping packing materials as evidence for shipper's confirmation.



### Attention!

This unit is in perfect condition before delivery, please check all accessories when unpacking the unit. User should follow this user manual to operate this unit, and make sure that you are clear on all laser safety information and unit operation before power it on. Any wrong operation will make this unit out of warranty.





Carefully moving after receiving it, checking whether there is any damage from shipping, and all the accessories in it.

NAME	QTY
LED system	1set
Power Cord	1pcs
User manual	1pcs
Stand	1pcs
Wireless Footswitch	1pcs
Packing Case	1set

# Safety Instructions

---

## Safety Instructions

-  To protect the environment, please try to recycle the packing material as much as possible.
-  The projector is for indoor use only, IP20. Use only in dry locations. Keep this device away from rain and moisture, excessive heat, humidity and dust. Do not allow contact with water or any other fluids, or metallic objects.
-  Don't throw this product away just as general trash, please deal with the product follow the abandon electronic product regulation in your country.
-  Locate the fixture in a well ventilated spot, away from any flammable materials and/or liquids. The fixture must be fixed at least 20cm from surrounding walls.
  - ◆ To avoid condensation to be formed inside, allow this unit to adapt to the surrounding temperatures when bringing it into a warm room after transport. Condense sometimes prevents the unit from working at full performance or may even cause damages.
  - ◆ Don't cover any ventilation openings as this may result in overheating.
  - ◆ Don't install it on flammable object.
  - ◆ Don not use it when maximum ambient temperature is higher than 40 degree.
  - ◆ Unplug the unit when it is not used for a longer time or before replacing the bulb.
  - ◆ Don't open the top cover to avoid unit damage.
  - ◆ Please use the original packing when the device is to be transported.
-  Never expose the lens to direct sunlight, even for a short period, this may damage the light effect or even cause fire!

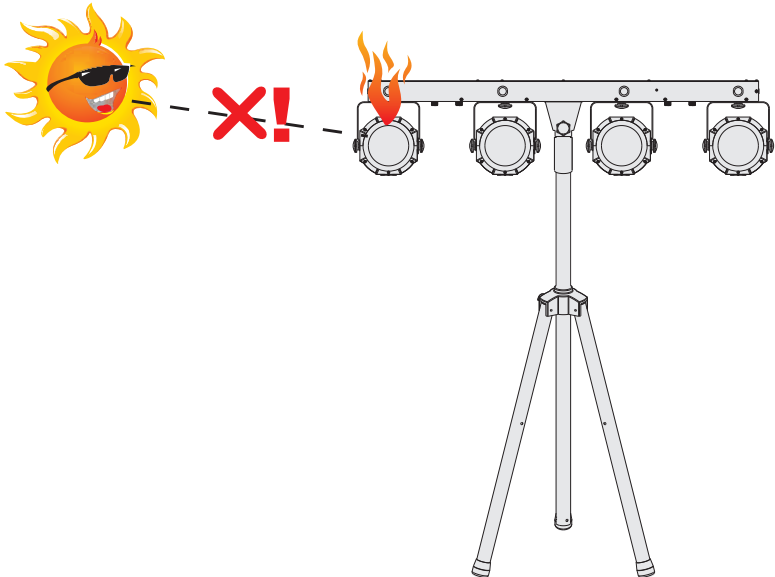

# Overhead Rigging

## Overhead Rigging



### Attention!

The installation must be carried out by qualified service personal only. Improper installation can result in serious injuries and /or damage to property. Overhead rigging required extensive experience! Working load limits should be respected, Certified installation materials should be used, the installed device should be inspected regularly for safety.

- ◆ Make sure the area below the installation place is free from unwanted persons during rigging, de-rigging and servicing.
- ◆ Locate the fixture in a well ventilated spot, far away from any flammable materials and/or liquids. The fixture must be fixed at least 50cm from surrounding walls
- ◆ The device should be installed out of reach of people and outside areas where persons may walk by or be seated.
- ◆ The device should be well fixed; a free swinging mounting is dangerous and may not be considered!
- ◆ Do not cover any ventilation opening as this may result in overheating
- ◆ Before the first time use, it must be inspected by professional staff to make sure safety, inspection regularly every year.

## AC Power

Please use the attached power, note that power voltage and frequency are the same as the marked voltage and frequency of device when connecting power. Every device's power should be connected separately, so that device can be controlled individually.

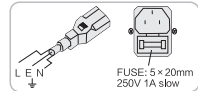

Cable spec.

Cable(EU)	Cable(US)	Pin	International
Brown	Black	Live	L
Light blue	White	Neutral	N
Yellow/Green	Yellow/Green	Earth	⊕

## DMX-512 connection

Connection between laser lights and DMX must use the shield cable of diameter more than 0.5mm. Please use the attached 3 pin XLR plug/socket to connect the DMX output/input interface. The connection between socket and cable as below( note the plug/socket's 3 pin number and position).

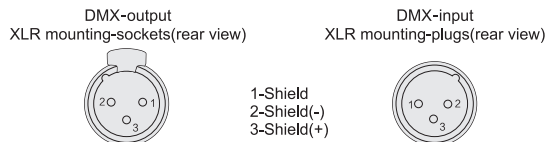

Note, XLR plug/socket's 3pin can not be touched by inner hull, connection between pins is not allowed. Except above connection, XLR plug/socket can not be connected with XLR control line. Device receives international standard DMX512(1990) control signal.

When using standard DMX512 control signal, the last device's output interface must be connected to a DMX plug. This plug is putting a 120 ohm resistance between "canon" plug's 2 pin and 3 pin. Showing as below pic. Sticking this plug into the last device's signal output interface, it will avoid the interference during the process of signal transmission.

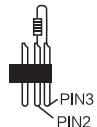

# Operation instructions

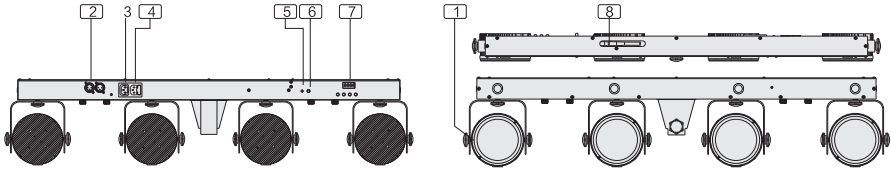

NO	FUNCTION	DESCRIPTION
1	LED PAR lights	4*RGBW-30W
2	DMX input/output	3PIN male/female XLR interface , for DMX communication
3	Power connection	Power output connect with next light
4	Power input	Power input socket, built-in protective tube and spare tube
5	Microphones	Receiving the audio signal through a microphone, and positive response to the intensity by the potentiometer
6	Potentiometer	To adjust the sound activated sensitivity
7	LCD control interface	Various mode setting operations of the machine
8	Wireless antenna	Receiving wireless footswitch signal

## Footswitch Operation Instruction

 NOTE: All the operations from the footswitch is invalid to the DMX mode and the SLAVE mode.

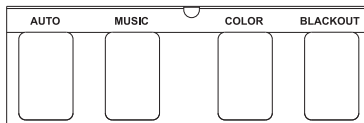

NAME	FUNCTION
AUTO	Press AUTO to activate the auto program controls. When working, all the lights will begin in auto mode.
SOUND	Press SOUND to activate the sound program controls. When working, all the lights will begin in sound mode.
COLO	RGBW Color Setting
Blackout	Light off.

# Menu operating instruction

☒ Once after every power on machine, the VERSION and MANUFACTURE INFORMATION will be shown in LED monitor of rear panel. When the machine is powered on, LED monitor on rear panel shows the current operating standalone mode or DMX address of DMX mode. With help of LED control panel, is very easy to set and change the operating mode. After every resetting and saved, the new mode information will be shown on LED monitor at next power.

**MENU** Model choice, return to the previous menu.

**ENTER** Go into the deeper menu.

**UP** For higher numeric value operation.

**DOWN** For lower numeric value operation.

LED Display		Functional Description
Aut	AuLP → AP01-AP17	PAR light auto mode
	AuLF → AF01-AF10	Flash light auto mode
	AuLN → AN01-AN03	Mix auto mode
	S.01-5.99	Effect speed adjustment. 01 is the slowest, 99 is the fastest
Sou	SouLP → SP01-SP12	PAR light sound mode
	SouLF → SF01-SF10	Flash light sound mode
	SouLN → SN01-SN03	Mix sound mode
Col	CoLo	Color manual adjustment
	r/G/b/R***	LED color setting
	S.00-5.99	Flash light speed adjustment. S.00: all on; S.99 is the fastest
SYN	SY-A	Synchronous auto mode
	SY-N	Synchronous sound mode
	S.01-5.99	Auto show speed. 01 is the slowest, 99 is the fastest. (Only valid under SY-A Mode)
dNH	d001	Signal reception mode (the worlds will strobe if there's no signal)
	03/06/28Ch	DMX channel selecting
	d***	Channel address setting
SLA	S001	Slave mode
	001-255	Address setting
SYS	n-En	Be the master for synchronous mode. (under AUTO/SOUND/COLOR Mode)
	W-En	Wireless pedal working mode
	tEst	Aging testing and main board testing program.
	rEst	Restore the factory initial setup

# Menu operating instruction

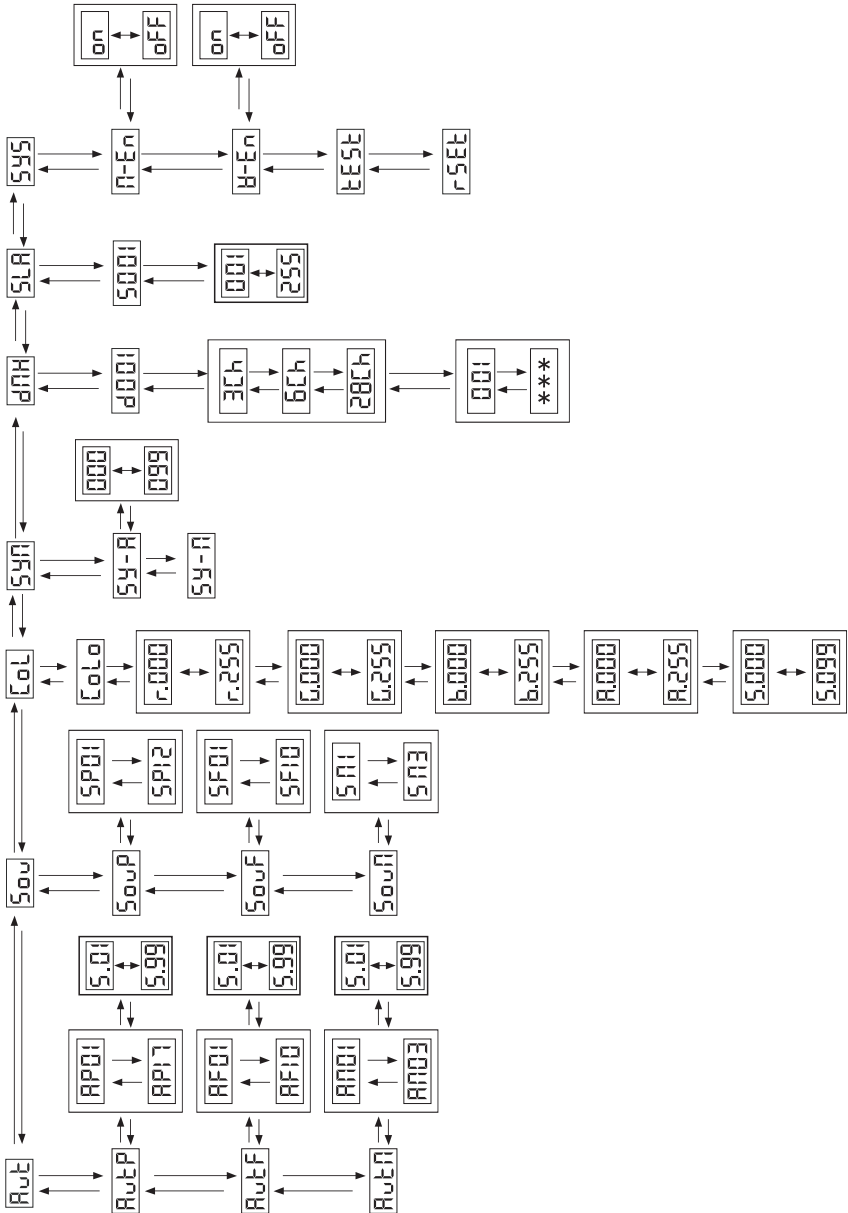

# Menu operating instruction

## Initial Setting

MENU	UP DOWN	ENTER	UP DOWN	ENTER
Built-in auto programs	AP01-AP17 PAR light auto show AF01-AF10 flash light auto show AM01-AM03 Mix auto show	ENTER into the next step. To choose the effect speed through the UP/DOWN button.	S.01-S.99: Effect speed adjustment. 01 is the slowest, 99 is the fastest	ENTER: confirm and back to the previous step.
Built-in sound programs	AP01-AP12 PAR light auto show AF01-AF10 flash light auto show Am01-AM03 Mix auto show	Enter to confirm. To adjust the sound sensitivity through the potentiometer.		
COLO color setting	R.000-R.255 G.000-G.255 B.000-B.255 W.000-W.255	ENTER into the next step. MENU to the previous step.	S.00—S.99: strobe speed S.00: all on, S.99: the fastest	ENTER: confirm and back to the previous step.
DMX mode	03/06/28CH	Selecting the channel	d001-dXXX	Setting the address
SLAVE mode	When selecting the SLAVE mode, this machine will follow the master's built-in program through the DMX cable.	ENTER into the next step	001-255 address setting	ENTER: confirm and back to the previous step.
System setting	M-En: master mode	ENTER into the next step	ON: turn on master mode OFF: turn off master mode	ENTER: confirm and back to the previous step.
	W-En: wireless pedal working mode	ENTER into the next step	ON: turn on the wireless footswitch working mode OFF: turn off the wireless footswitch working mode	ENTER: confirm and back to the previous step.
	TEST: texting mode	ENTER to the testing mode		
	REST: restore the factory initial setup	ENTER to restart the machine		



- NOTES:**
- (1) S.01-S.99: program speed adjusting; S.01: the slowest, S.99: the fastest
  - (2) A point will be shown on the screen if there's no operation in 30s.
  - (3) Machine address bit instruction, face to the LED screen, from left to right, the address is 1-2-3-4.
  - (4) The nixie tube will twinkle when there's no signal input to SLAVE,D001.



# DMX operation instructions

---

DMX Channels Chart This device adopts large storage and high speed chip, which has been written lots of effect based on laser light DMX application. There are many kinds of model in channel one.

## 3CH

Channel	Value	Description
CH1	000-009	Blackout
	010-050	Auto Par show
	051-090	Auto LED Flash show
	091-130	Mix auto show
	131-170	Sound Par show
	171-210	Sound LED flash show
	211-255	Mix sound show

Channel	Function	Value	Description
CH2	Auto Par show	000-014	AUTO PAR1
		015-029	AUTO PAR2
		030-044	AUTO PAR3
		045-059	AUTO PAR4
		060-074	AUTO PAR5
		075-089	AUTO PAR6
		090-104	AUTO PAR7
		105-119	AUTO PAR8
		120-134	AUTO PAR9
		135-149	AUTO PAR10
		150-164	AUTO PAR11
		165-179	AUTO PAR12
		180-194	AUTO PAR13
		195-209	AUTO PAR14
		210-224	AUTO PAR15
		225-239	AUTO PAR16
		240-255	AUTO PAR17
	Auto LED Flash show	000-024	AUTO LED1
		025-049	AUTO LED2
		050-074	AUTO LED3
		075-099	AUTO LED4
		100-124	AUTO LED5
		125-149	AUTO LED6
		150-174	AUTO LED7
		175-199	AUTO LED8
		200-224	AUTO LED9
		225-255	AUTO LED10

# DMX operation instructions

## 3CH

Channel	Function	Value	Description
CH2	MIS Auto show	000-099	MIX AUTO 1
		100-199	MIX AUTO 2
		200-255	MIX AUTO 3
	Sound PAR show	000-019	SOUND PAR1
		020-039	SOUND PAR2
		040-059	SOUND PAR3
		060-079	SOUND PAR4
		080-099	SOUND PAR5
		100-119	SOUND PAR6
		120-139	SOUND PAR7
		140-159	SOUND PAR8
		160-179	SOUND PAR9
		180-199	SOUND PAR10
		200-219	SOUND PAR11
		220-255	SOUND PAR12
	Sound LED Flash show	000-024	SOUND LED1
		025-050	SOUND LED2
		050-074	SOUND LED3
		075-099	SOUND LED4
		100-124	SOUND LED5
		125-149	SOUND LED6
		150-174	SOUND LED7
		175-199	SOUND LED8
		200-224	SOUND LED9
		225-255	SOUND LED10
	MIX Sound show	000-099	MIX SOUND1
		100-199	MIX SOUND2
		200-255	MIX SOUND3

Channel	Value	Description
CH3	000-255	Program speed setting

# DMX operation instructions

---

## 6CH

Channel	Value	Description
CH1	000–255	Red Dimmer
CH2	000–255	Green Dimmer
CH3	000–255	Blue Dimmer
CH4	000–255	White Dimmer
CH5	000–191	Total Dimmer
	192–200	Sound Flash
	201–249	Flash Speed
	250–255	All On
CH6	000–255	White Flash Speed

## 28CH

Channel	Value	Description
CH1	000–255	Red Dimmer
CH2	000–255	Green Dimmer
CH3	000–255	Blue Dimmer
CH4	000–255	White Dimmer
CH5	000–255	Total Dimmer
CH6	000–255	Flash Speed
CH7	000–255	Red Dimmer
CH8	000–255	Green Dimmer
CH9	000–255	Blue Dimmer
CH10	000–255	White Dimmer
CH11	000–255	Total Dimmer
CH12	000–255	Flash Speed
CH13	000–255	Red Dimmer
CH14	000–255	Green Dimmer
CH15	000–255	Blue Dimmer
CH16	000–255	White Dimmer
CH17	000–255	Total Dimmer
CH18	000–255	Flash Speed
CH19	000–255	Red Dimmer
CH20	000–255	Green Dimmer
CH21	000–255	Blue Dimmer
CH22	000–255	White Dimmer
CH23	000–255	Total Dimmer
CH24	000–255	Flash Speed
CH25	000–255	Flash Speed of 1 <sup>st</sup> LED
CH26	000–255	Flash Speed of 2 <sup>nd</sup> LED
CH27	000–255	Flash Speed of 3 <sup>rd</sup> LED
CH28	000–255	Flash Speed of 4 <sup>th</sup> LED

# Product Parameter

## Specifications

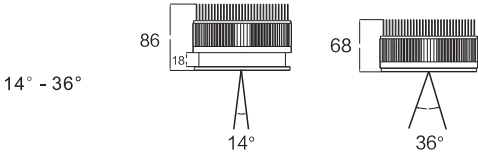
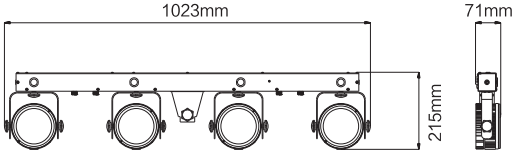
Model	Scandlight T-BAR Lightset COB	
Power:	130W	
PAR LED:	4*RGBW-30W	
Beam angle:	120°	
LED:	R-630nm/310lm, G-515nm/450lm, B-460nm/160lm, W- 7000K/520lm	
DMX channels:	3, 6, 28CH	
Spare parts:	T-Bar, stand, carrying bag, wireless footswitch, IR remote control, standing foot	
Power linking:	10pcs@240V	
AC power:	switching power supply, 100V-240V 50/60Hz (for all international markets)	
Fuse:	T 3.15A, 250V	
Stand:	1.5m-2.5m ( adjustable )	
Weight:	11.2Kg	
Product size:	L1023 × W71 × H215mm	
Packing size:	L1057 × W145 × H457mm	
Zoom Angle:	 <p>14° - 36°</p>	
	 <p>1023mm 215mm 71mm</p>	